

ASSEMBLY INSTRUCTIONS

FORUM & PILO

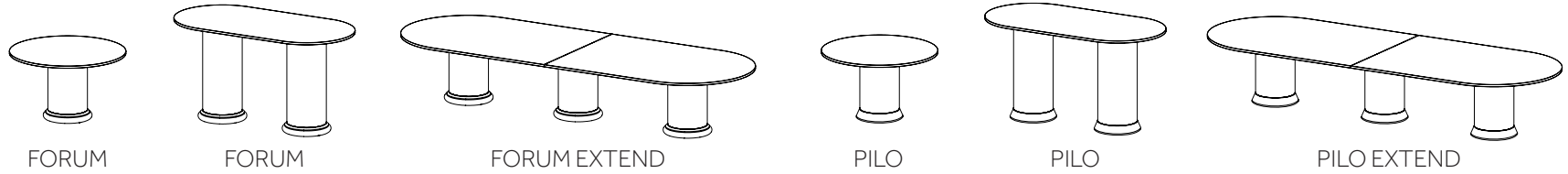

COMPONENTS

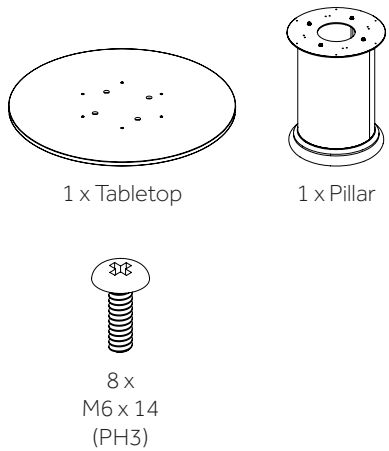

TABLETOP (with sockets)

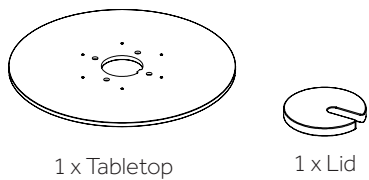

1 Use a hand truck / wheel dolly to place the pillar where the table will stand in the future.

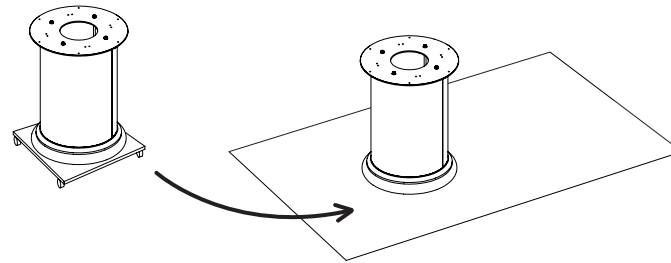

2 Place the tabletop on the pillar, making sure the nuts in the pillar fit into the holes in the tabletop.

Use a cross-head screwdriver to screw 8 x M6 screws to attach the tabletop.

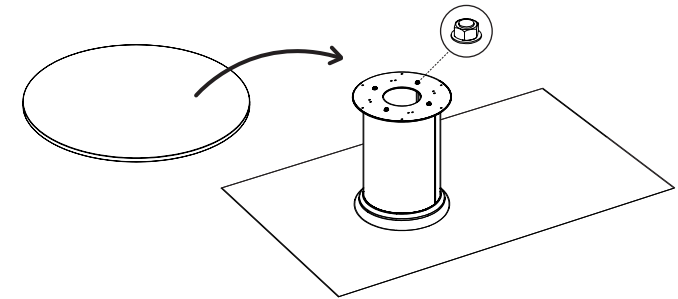

3 If you need to move the table a bit further, remove the tabletop.

Don't lift the table in the tabletops due to the heavy pillars.

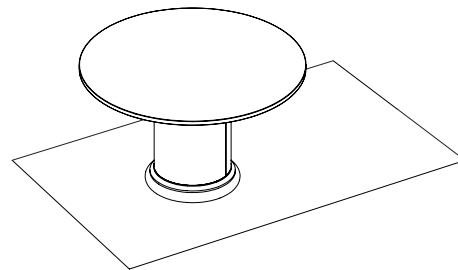

Required tools:
Cross head screwdriver.
Hand truck / Wheel dolly.

MONTERINGSANVISNING

FORUM & PILO

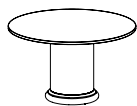

FORUM

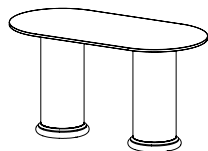

FORUM

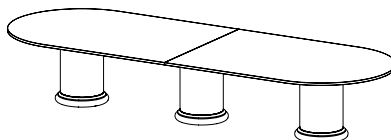

FORUM EXTEND

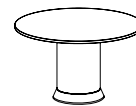

PILO

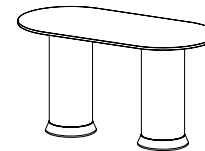

PILO

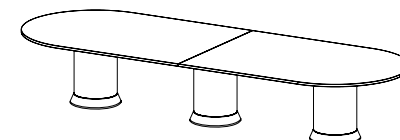

PILO EXTEND

KOMPONENTER

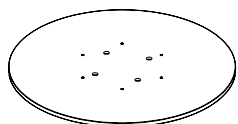

1 x Bordsskiva

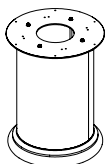

1 x Pelare

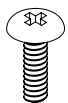

8 x
M6 x 14
(PH3)

SKIVA (för eluttåg)

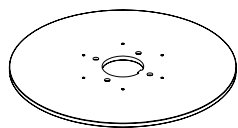

1 x Tabletop



1 x Lid

- 1 Använd en pirra / hjulplatta för att placera pelaren där bordet kommer att stå framöver.

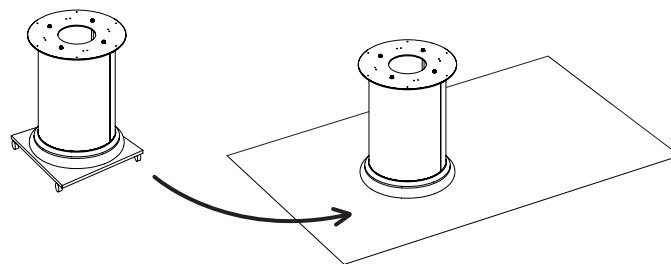

- 2 Placera bordsskivan på pelaren och se till att muttrarna i pelaren passar in i hålen i bordsskivan.

Använd en skruvmejsel för att skruva 8 x M6-skrivar för att fästa bordsskivan.

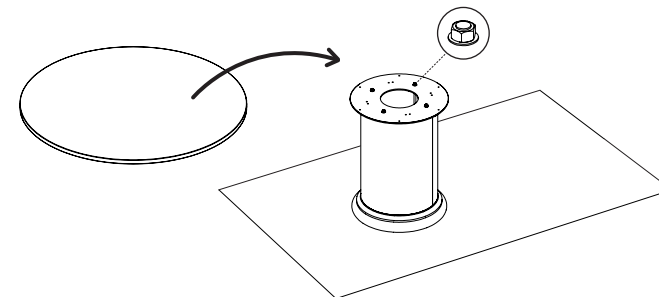

- 3 Om du behöver flytta bordet lite längre, ta bort bordsskivan.

Lyft inte bordet i bordsskivan på grund av de tunga pelarna.

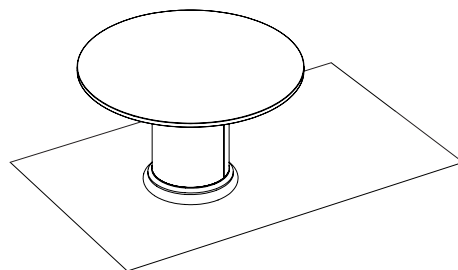

Verktyg för montering:
Stjärnskruvmejsel.
Pirra / Hjulplatta.